

## POLYSCREED SL ESD

2 to 3 mm Anti-static Polyurethane Floor Screed

A high performance four component anti-static polyurethane self-smoothing floor screed providing exceptional physical and chemical resistance as well as electrostatic discharge protection in industrial environments subjected to light-medium traffic. It provides a smooth, yet non slip, floor finish ideal for applications in electronic environments, pharmaceutical and manufacturing industries where high performance, durability and adherence to BS 2050:1978 are required. HACCP compliant with antimicrobial silver ion technology ideal for food processing areas.



### BENEFITS:



*High chemical resistance.*



*High impact, abrasion and thermal shock resistance.*



*Electrostatic dissipative.  
5 x 10<sup>4</sup> to 10<sup>8</sup> Ω,  
BS: 2050-1978*



*Seamless and easy to clean.  
Antimicrobial silver ion technology. Low VOC*



*Fast installation.  
Easy to use fluid consistency with excellent adhesion.*



*HACCP compliant,  
Ideal for food processing areas.*

### TECHNICAL DETAILS

Compressive Strength	>50 MPa	BS6319
Tensile Strength	>12 MPa	
Flexural Strength	>20 MPa	
Concrete Adhesion	>1.5 MPa (Concrete failure)	ASTM D7234
Impact Resistance	1 kg >1.8 m 2 kg >1.5 m	ISO6272-1:2011
Hardness	80	Shore D
Slip Resistance	Dry >70 Wet >25	TRRL Pendulum Slip Test
Vapour Permeability	5 g/m <sup>2</sup> /24 hrs @4mm	ASTM E96:90
Water Uptake (Permeability)	Nil	Karsten Test
Anti-static Performance	5 x 10 <sup>4</sup> to 5 x 10 <sup>8</sup> Ω	BS 2050
Heat Resistance	-5°C to 60°C @ 2 mm -15°C to 80°C @ 3 mm	
Chemical Resistance	Refer to chemical chart	
Foot Traffic	12 to 16 hrs	
Heavy Traffic	24 hrs	
Kit Yield	19 L	
Coverage @ 2 mm	7.6 m <sup>2</sup> (5 mm rake)	
Coverage @ 3 mm	6.36 m <sup>2</sup> (8 mm rake)	
PACKAGING		
Part 1	4.9 kg (White Liquid)	
Part 2	5 kg (Brown Liquid)	
Part 3	0.6 kg (Pigmented Liquid)	
Part 4	2 x 12.5 kg (Aggregate)	
Part 5	Conductive Fibre	
Total Kit	35.5 kg	
SYSTEM PRODUCT REQUIREMENTS		
Primer:	Solidkote UP Primer	
Copper tape:	Copper grid (10mm tape) with earth	
Middle layer:	Solidkote UP Primer & Conductive Aggregate SL broadcast	
Screed:	Polyscreed SL ESD	

#### Gauteng

35 Activia Rd, Activia Park, Germiston, 1610  
Tel: +27 11 822 7242

#### Kwa-Zulu Natal

41 Circuit Rd, New Germany, 3610  
Tel: +27 31 705 7733

#### Western Cape

Cnr Gunners Circle & Fisher Ave, Epping 1, 7475  
Tel: +27 21 535 4455

## APPLICATIONS:

- Electronic environments
- Packaging areas
- Food processing plants
- Medium traffic production plants
- Warehousing
- Chemical processing plants
- Wet or dry processing plants
- Breweries
- HACCP environments

## SUBSTRATE REQUIREMENTS

Concrete substrates must have a minimum compressive strength of 20 to 25 MPa, a minimum tensile pull-off strength of 1.5 MPa and be free of oil, fat, grease, dust, and loose friable materials. The moisture content should be less than 5% and free from rising damp.

Note: Any filling of blowholes/voids and surface levelling of substrate can be achieved using appropriate products within Technical Finishes Construction Range (please speak to one of our technical sales representatives).

## PREPARATION

Remove all previous coatings, unbonded concrete and laitance mechanically through diamond grinding, abrasive blasting or scarifying to obtain a sound and porous surface (sandpaper texture). Sweep dust and loose debris followed by vacuuming, to obtain a dry and dust-free surface. It is standard practice to ensure grooves 5 mm by 5 mm, run parallel to and 150 mm from all walls, plinths, finished edges, expansion joints, columns.

## PRIMING

Ensure application conditions of 15 to 28°C and that the concrete has a moisture content below 5%.

Prime with Solidkote UP Primer.

Allow Solidkote UP Primer to cure for at least 8 hours prior to application of Polyscreed SL ESD with a maximum over coating time of 18 hours.

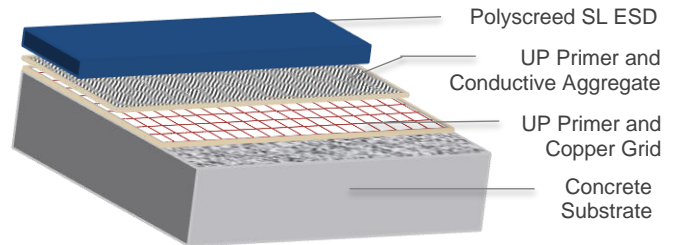

## EARTHING

Providing the substrate has intimate contact with underlying ground, no additional earthing requirements will be needed.

However, in the instance of raised or insulated floor levels, a network of copper tape should be fixed to the blasted floor between primer layers.

Apply copper tape grid on cured Solidkote UP Primed surface as indicated in the diagram below.

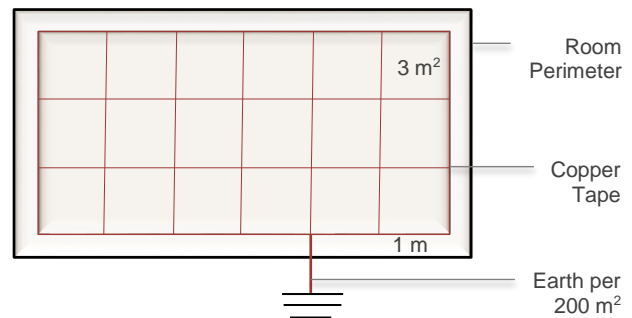

### Copper Tape Grid

Lay the copper grid 1 m from the room perimeter. Each copper tape forming the grid should be placed a maximum of 3 m apart. Hence, the copper tape forms a grid with squares with surface area of 3 m<sup>2</sup>, as seen in the figure above.

### Earth Connection

Ensure there is an earth for every 200 m<sup>2</sup> of surface (the copper grid should be secured to a main earthing frame. A multi-strand piece of copper wire is connected to the main earthing frame at one end and spread out like a fan against the surface of the floor and taped down with the copper tape that forms part of the copper grid). The self-adhesive copper tape should be fully adhered to primed surface (apply pressure).

## Joists

Allow the copper tape to fold down into joints, across the joint line, to bridge any potential electrostatic dissipative breaks in the copper grid across the floor. Apply a bondbreaker to the copper tape within the joint to form a slip joint. Consequent filling of joints can be achieved using appropriate products within Technical Finishes Construction Range (please speak to one of our technical sales representatives).

In the event that areas separated by expansion joints cannot be bridged by copper tape, they should be treated as isolated areas and be individually earthed.

## INSTALLATION:

Ensure application conditions of 15 to 28°C. Ensure adequate lighting to achieve an even and level spread. Installation should not be attempted unless application team is fully trained.

### *Solidkote UP Primer and Conductive Aggregate*

Apply Solidkote UP Primer as per Technical Data Sheet. Broadcast conductive aggregate into wet primer until refusal (full blind). Sweep unbonded conductive aggregate followed by vacuuming.

Measure the electrical resistance across the prepared floor, and ensure that it is within the required range, prior to the application of Polyscreed SL ESD.

Allow primer to cure for at least 8 hours prior to application of Polyscreed SL ESD with a maximum over coating time of 18 hours.

### *Polyscreed SL ESD*

Open both aggregate bags (Part 4) before the mixing starts to ensure no time is wasted between mixes/kits. Shake Part 1, Part 2 and Part 3 vigorously prior to opening.

Set up the mixing machine as close to the floor as possible (Use two mixing vessels to ensure time between mixes/kits is minimized).

Decant Part 1 and Part 3 into mixing vessel and mix for 5 seconds (until uniform). Add Part 5 (Conductive Fibres) into mixing vessel and mix for 20 seconds to disperse the fibres.

Start timer when adding Part 2 and mix for 30 seconds. Once 30 seconds is complete, pour Part 4 into the mix and mix for a further 2 minutes until uniformly wetted out.

Pour out the mix onto the demarcated area in a long ribbon and pull the mix with an 5 mm or 8 mm notched rake. As soon as the first mix has been troweled, the next mix should be delivered to the floor and placed

into the previous mix. Spike roll immediately to remove trowel marks and mix joint regions (regions where two mixes meet). Ensure spiking is within 8 minutes of the start time of each mix. Allow the surface to settle and cure.

## MAINTENANCE

Regular cleaning extends the service life of the Polyscreed system. Maintenance is to be carried out using Liquid Action which complies with SANS 1344 Medium Duty Solvent Detergent (2112/P3325/10/ID). Please refer to full cleaning regime for Polyscreed polyurethane flooring systems.

## ANTIMICROBIAL RESISTANCE

An important advantage of the Polyscreed range is its silver ion technology which inhibits the growth of bacteria and fungi ensuring a more hygienic surface.

## HEALTH AND SAFETY

Please read Safety Data Sheet and specific health and safety data for this product provided in compliance with the requirements of OHS Act No.85 of 1993. The finished system is not hazardous to health or the environment.

## WARRANTY

Technical Finishes products are manufactured under high quality standards and are warranted against defective materials and are sold subject to standard Terms and Conditions of Sale, copies of which can be obtained upon request. Technical Finishes deals with approved applicators and carry a back to back warranty with these clients. Technical Finishes cannot be held responsible for the workmanship in surface preparation and application of our products, it is understood that the approved contractor will guarantee such workmanship and application. It is vital that the application is done in accordance to our specification.

---

### Gauteng

35 Activia Rd, Activia Park, Germiston, 1610  
Tel: +27 11 822 7242

[info@technicalfinishes.com](mailto:info@technicalfinishes.com)

### Kwa-Zulu Natal

41 Circuit Rd, New Germany, 3610  
Tel: +27 31 705 7733

### Western Cape

Cnr Gunners Circle & Fisher Ave, Epping 1, 7475  
Tel: +27 21 535 4455

[www.trchnicalfinishes.com](http://www.trchnicalfinishes.com)

**JOINT DETAIL**

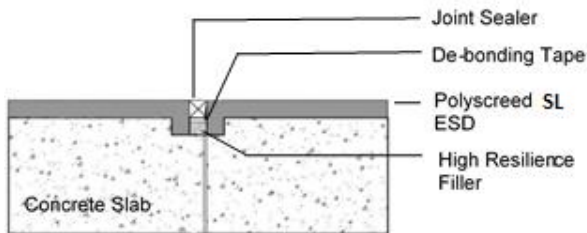

*Low Movement Joint Detail*

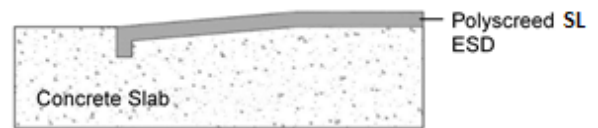

*Termination Detail*

**COVING DETAIL**

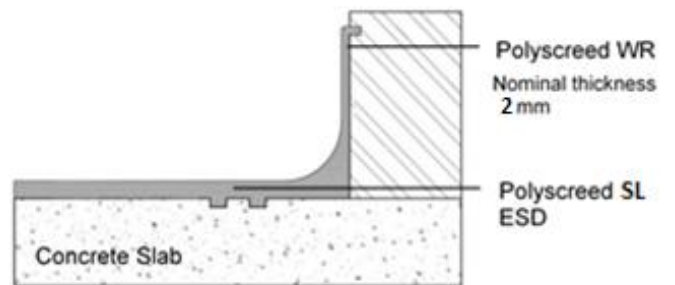
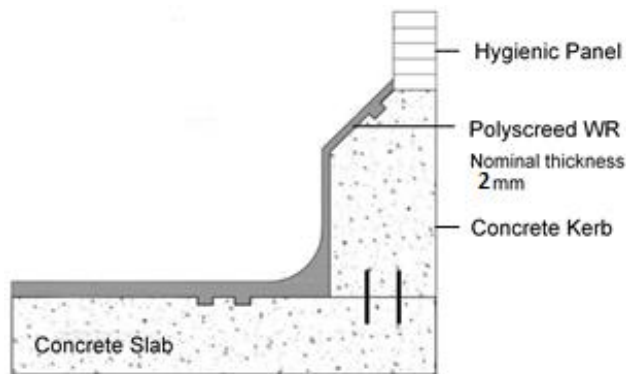

**CHANNEL LININGS**

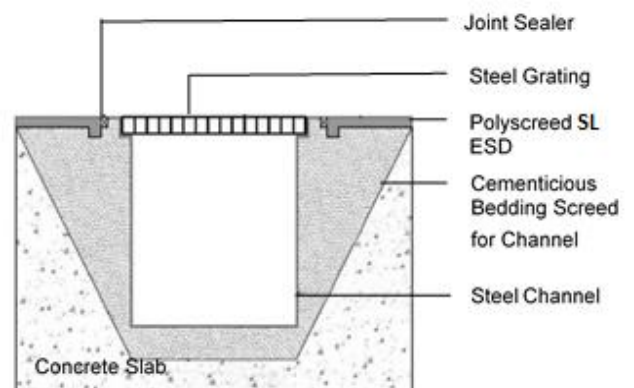
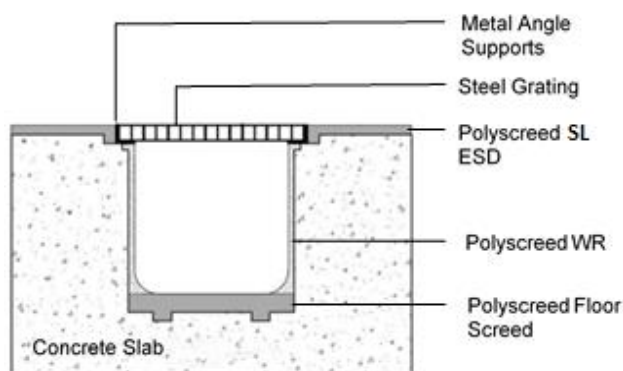

**Gauteng**

35 Activia Rd, Activia Park, Germiston, 1610  
Tel: +27 11 822 7242

info@technicalfinishes.com

**Kwa-Zulu Natal**

41 Circuit Rd, New Germany, 3610  
Tel: +27 31 705 7733

**Western Cape**

Cnr Gunners Circle & Fisher Ave, Epping 1, 7475  
Tel: +27 21 535 4455

www.trchnicalfinishes.com